

PIXEL SPHERE SUSPENSION

D1010059- _____

base number Color Finish
 Temperature Options

- To build a product code in our configurator select the specify button on the base model # product page
- To build a manual product code on this datasheet choose from the options listed below in blue font and add the suffix to the base model #

GENERAL

Series: Pixel Sphere
 Partner: Quasar
 Division: Design
 Installation: Suspension
 Product Type: Chandelier
 Mounting Location: Ceiling

PHYSICAL

Shape: Sphere
 Diameter (mm): 2030
 Diameter (in): 79 ¹⁵/₁₆
 Height (mm): 1700
 Height (in): 66 ¹⁵/₁₆
 Max. Overall Height (mm): 3700
 Max. Overall Height (in): 145 ¹¹/₁₆
 Fixture Finish: [NIC / BRA / BBR](#)
 Fixture Material: Metal
 Cable Details: 2000mm/78 3/4" Transparent Cable

ELECTRICAL

Lamp Type: LED
 Input Wattage (W): 876
 Total Output Wattage (W): 745
 Max. Wattage Per Lamp (W): 0.6
 Dimming: Phase Dimming (120Vac Only)
 Driver Included: Yes
 Driver Location: Integrated
 Driver Type: Constant Voltage - Universal
 Driver Class: Class 1
 Input Voltage (V): 120 - 277
 Output Voltage (V): 12

LED

Number of LEDs: 1476
 Color Temperature (°K): [2400 / 2800](#)
 Max. Delivered Lumen (lm): 44280
 CRI: >90 CRI
 Lamp Life (hrs): 50000

OPTICAL

RATINGS AND CERTIFICATIONS

Certified By: Certified for North American Standards
 IP rating: IP20

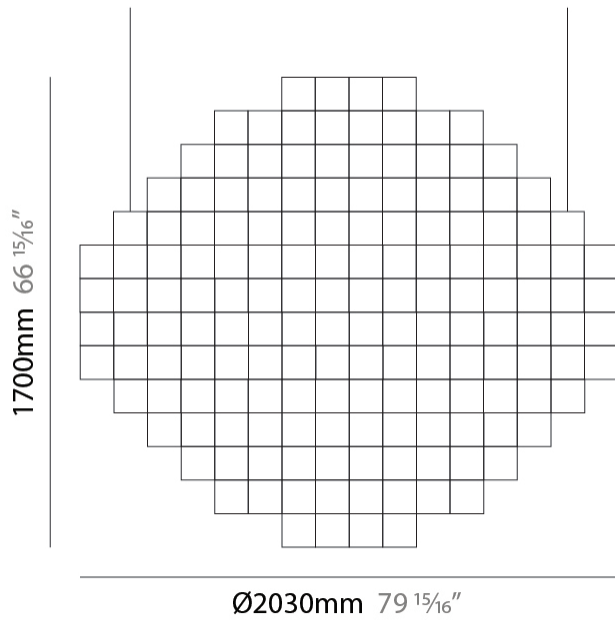
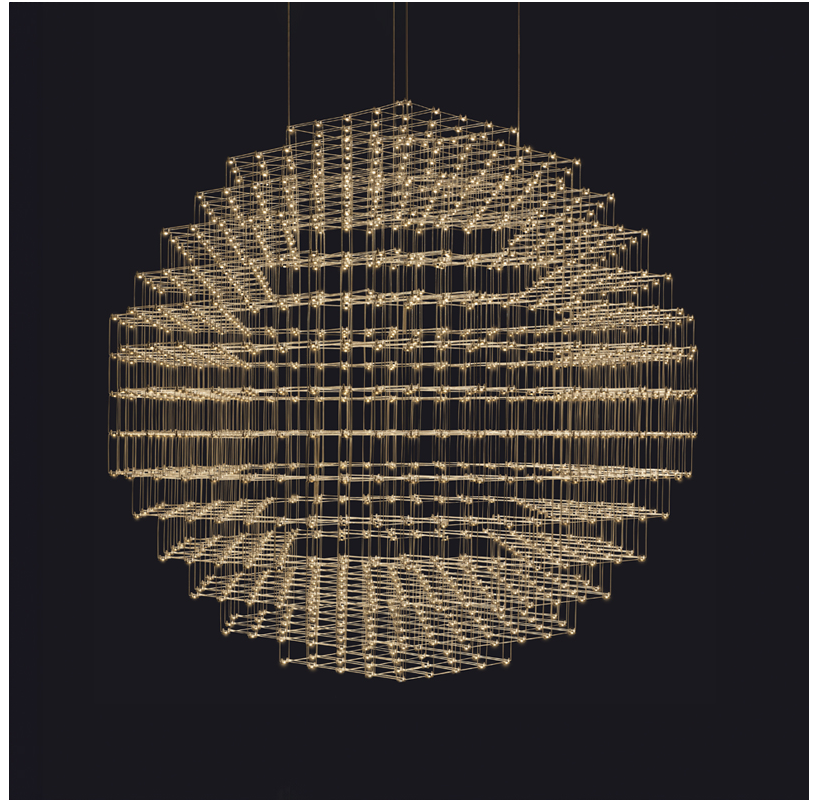

PIXEL SPHERE SUSPENSION

D1010059-

PROJECT _____

TYPE _____

SPECIFIER _____

QUANTITY _____

DATE _____

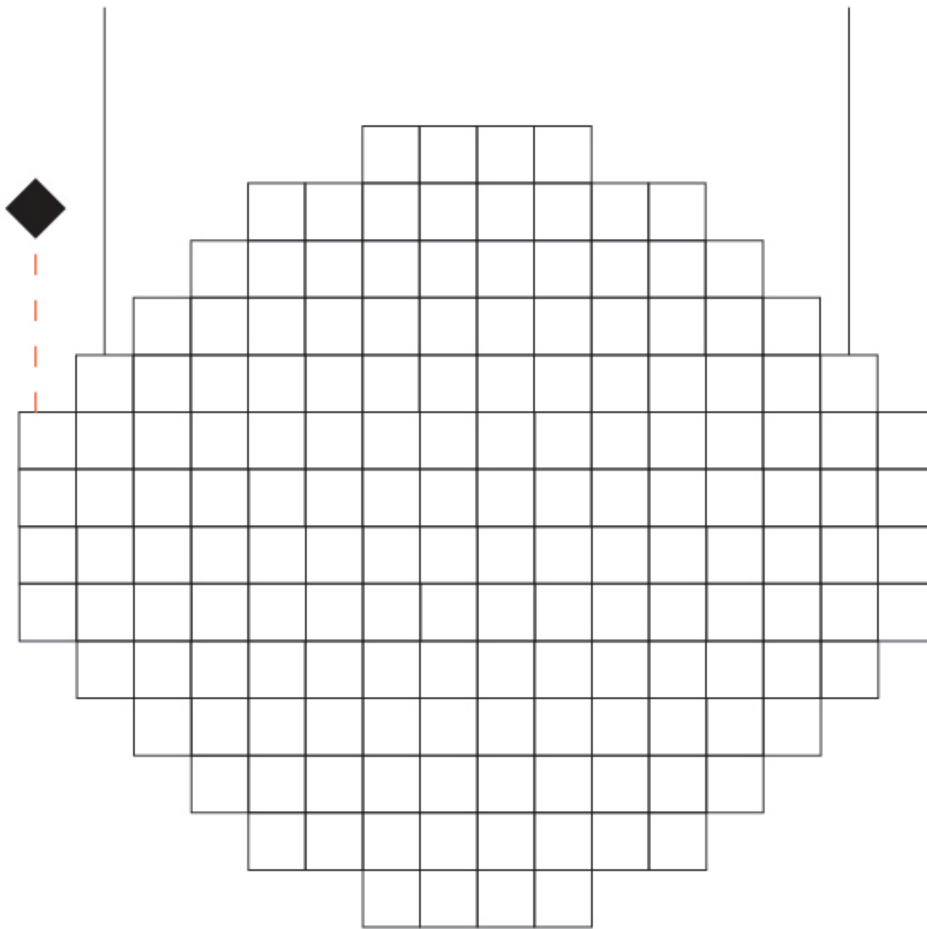

D

PIXEL SPHERE SUSPENSION

D1010076-

base number Color Finish
 Temperature Options

- To build a product code in our configurator select the specify button on the base model # product page
- To build a manual product code on this datasheet choose from the options listed below in blue font and add the suffix to the base model #

GENERAL

Series: Pixel Sphere
 Partner: Quasar
 Division: Design
 Installation: Suspension
 Product Type: Chandelier
 Mounting Location: Ceiling

PHYSICAL

Shape: Sphere
 Diameter (mm): 900
 Diameter (in): 35 ⁷/₁₆
 Width (mm): 100
 Width (in): 4 ¹⁵/₁₆
 Height (mm): 100
 Height (in): 4 ¹⁵/₁₆
 Max. Overall Height (mm): 2100
 Max. Overall Height (in): 82 ¹¹/₁₆
 Fixture Finish: [NIC](#) / [BRA](#) / [BBR](#)
 Fixture Material: Metal
 Cable Details: 2,000mm/78 3/4" Transparent Cable

ELECTRICAL

Lamp Type: LED
 Input Wattage (W): 288
 Total Output Wattage (W): 245
 Max. Wattage Per Lamp (W): 0.6
 Dimming: 0-10V Dimming / Phase Dimming (120Vac Only)
 Driver Included: Yes
 Driver Location: Integrated
 Driver Type: Constant Voltage - Universal
 Driver Class: Class 1
 Input Voltage (V): 120 - 277
 Output Voltage (V): 12

LED

Number of LEDs: 480
 Color Temperature (°K): [2400](#) / [2800](#)
 Max. Delivered Lumen (lm): 14400
 CRI: >90 CRI
 Lamp Life (hrs): 50000

OPTICAL

RATINGS AND CERTIFICATIONS

Certified By: Certified for North American Standards
 IP rating: IP20

PROJECT _____
 TYPE _____
 SPECIFIER _____
 QUANTITY _____
 DATE _____

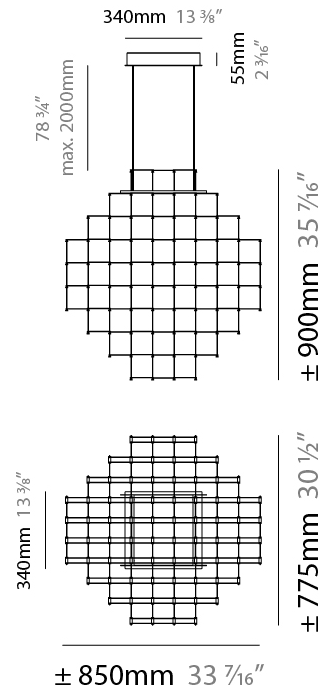
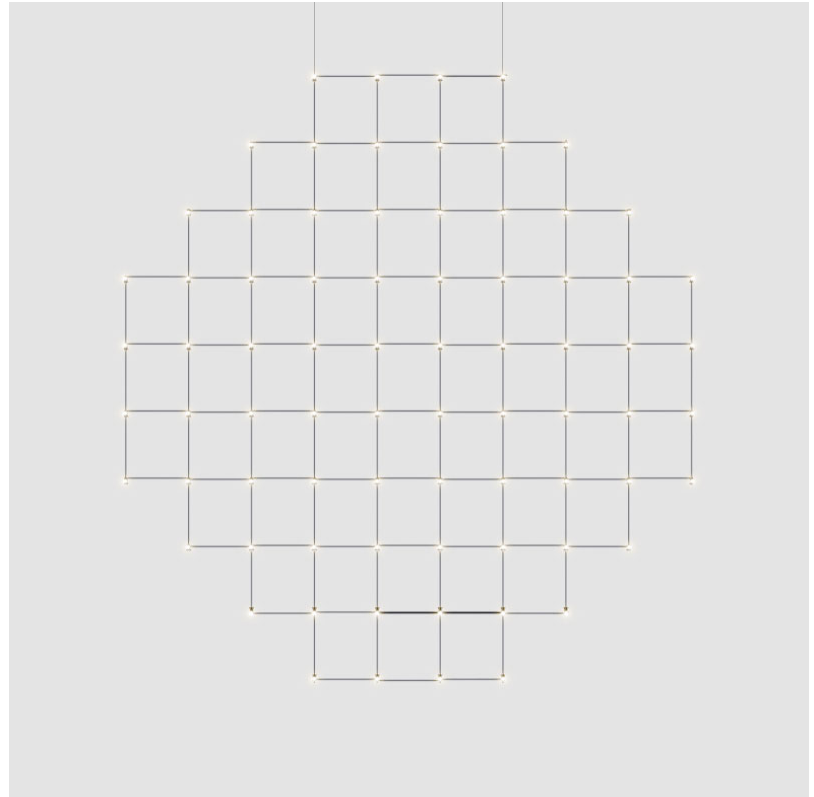

PIXEL SPHERE SUSPENSION

D1010076-

PROJECT

TYPE

SPECIFIER

QUANTITY

DATE

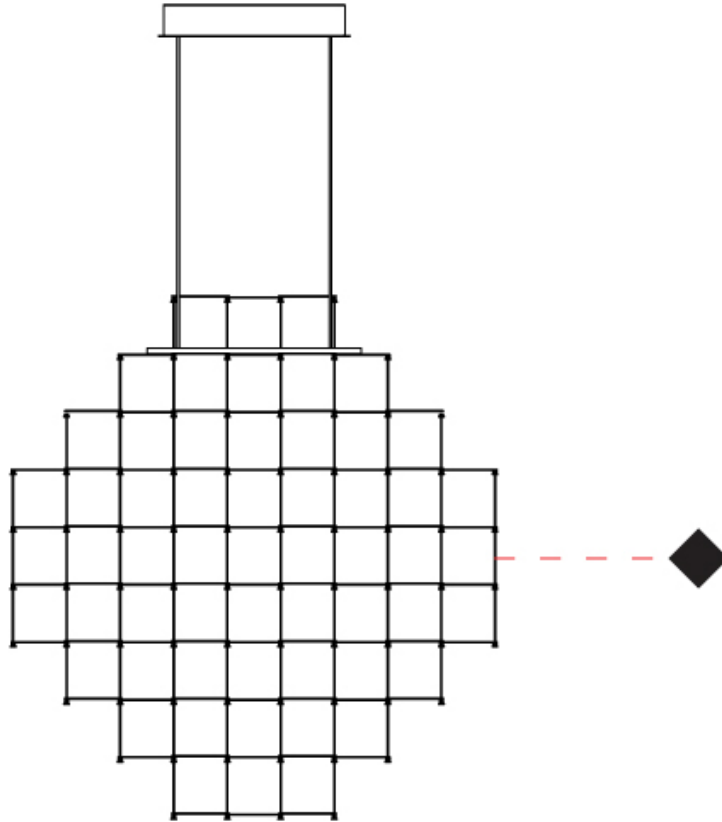

D

PIXEL SPHERE SUSPENSION

D1010077- -

base number Color Finish
 Temperature Options

PROJECT _____
 TYPE _____
 SPECIFIER _____
 QUANTITY _____
 DATE _____

- To build a product code in our configurator select the specify button on the base model # product page
- To build a manual product code on this datasheet choose from the options listed below in blue font and add the suffix to the base model #

GENERAL

Series: Pixel Sphere
 Partner: Quasar
 Division: Design
 Installation: Suspension
 Product Type: Chandelier
 Mounting Location: Ceiling

PHYSICAL

Shape: Sphere
 Diameter (mm): 900
 Diameter (in): 35 ⁷/₁₆
 Width (mm): 125
 Width (in): 4 ¹⁵/₁₆
 Height (mm): 125
 Height (in): 4 ¹⁵/₁₆
 Max. Overall Height (mm): 2125
 Max. Overall Height (in): 83 ¹¹/₁₆
 Fixture Finish: [NIC](#) / [BRA](#) / [BBR](#)
 Fixture Material: Metal
 Cable Details: 2,000mm/78 3/4" Transparent Cable

ELECTRICAL

Lamp Type: LED
 Input Wattage (W): 168
 Total Output Wattage (W): 143
 Max. Wattage Per Lamp (W): 0.6
 Dimming: 0-10V Dimming / Phase Dimming (120Vac Only)
 Driver Included: Yes
 Driver Location: Integrated
 Driver Type: Constant Voltage - Universal
 Driver Class: Class 1
 Input Voltage (V): 120 - 277
 Output Voltage (V): 12

LED

Number of LEDs: 280
 Color Temperature (°K): [2400](#) / [2800](#)
 Max. Delivered Lumen (lm): 4800
 CRI: >90 CRI
 Lamp Life (hrs): 50000

OPTICAL

RATINGS AND CERTIFICATIONS

Certified By: Certified for North American Standards
 IP rating: IP20

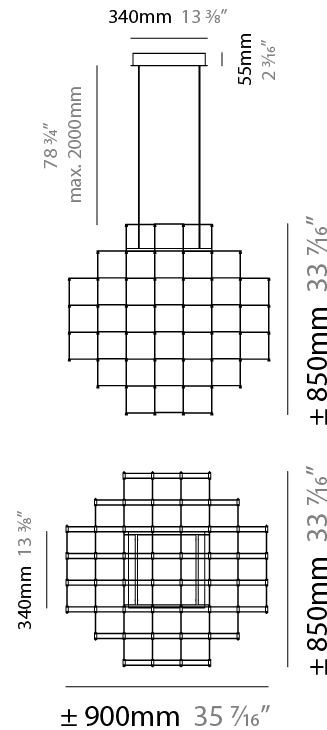
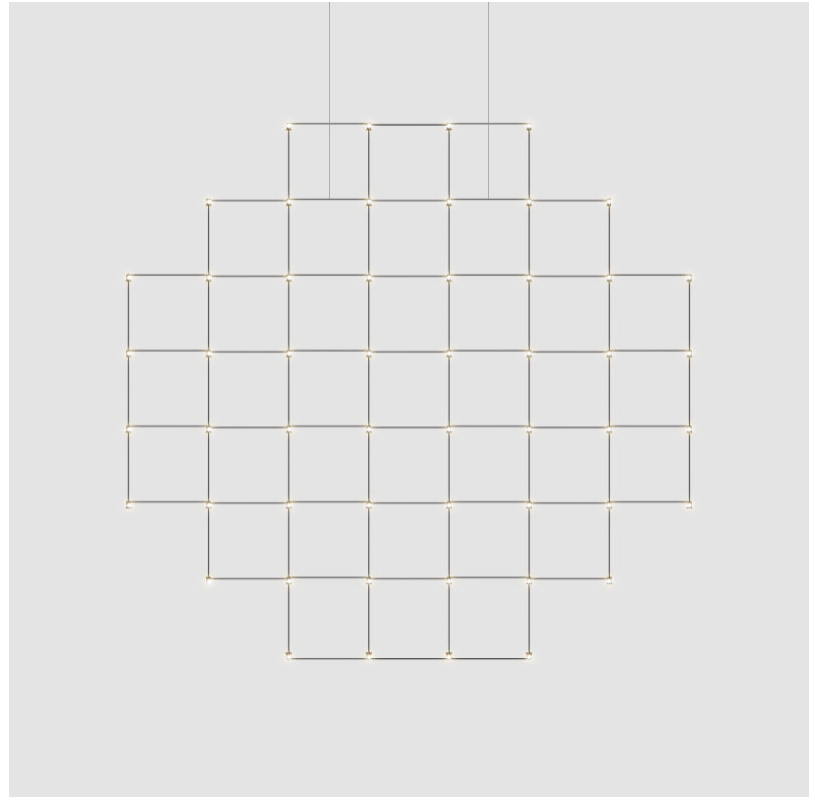

PIXEL SPHERE SUSPENSION

D1010077-

PROJECT _____

TYPE _____

SPECIFIER _____

QUANTITY _____

DATE _____

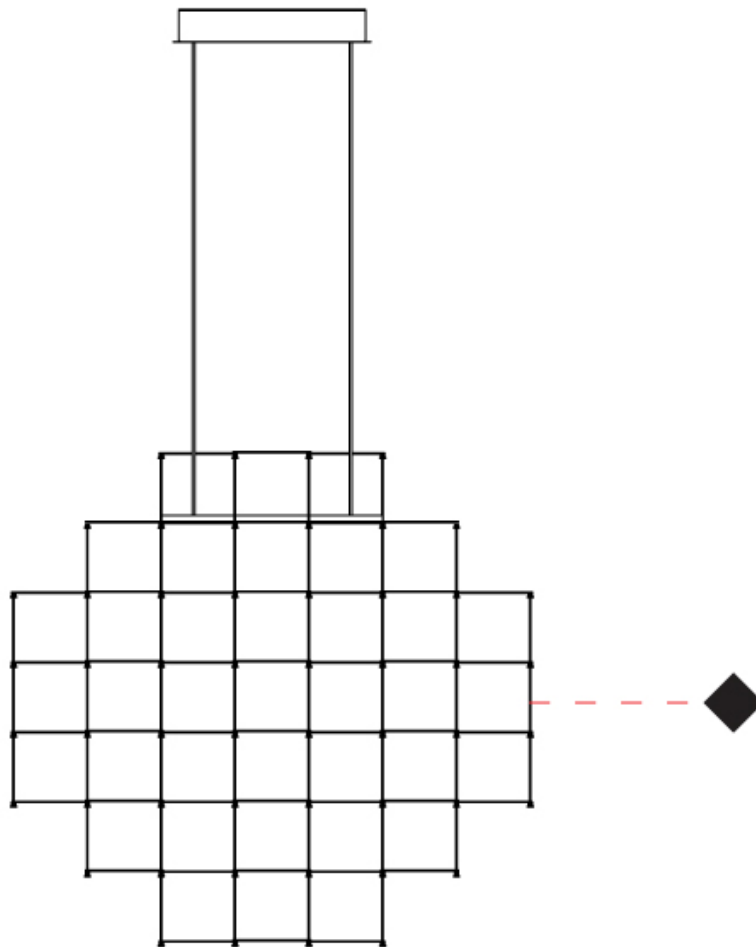

D

PIXEL SPHERE SUSPENSION

D1010078- -

base number Color Finish
 Temperature Options

- To build a product code in our configurator select the specify button on the base model # product page
- To build a manual product code on this datasheet choose from the options listed below in blue font and add the suffix to the base model #

GENERAL

Series: Pixel Sphere
 Partner: Quasar
 Division: Design
 Installation: Suspension
 Product Type: Chandelier
 Mounting Location: Ceiling

PHYSICAL

Shape: Sphere
 Diameter (mm): 1100
 Diameter (in): 43 ¹⁵/₁₆
 Width (mm): 100
 Width (in): 3 ¹⁵/₁₆
 Height (mm): 100
 Height (in): 3 ¹⁵/₁₆
 Max. Overall Height (mm): 2100
 Max. Overall Height (in): 82 ¹¹/₁₆
 Fixture Finish: [NIC](#) / [BRA](#) / [BBR](#)
 Fixture Material: Metal
 Cable Details: 2,000mm/78 3/4" Transparent Cable

ELECTRICAL

Lamp Type: LED
 Input Wattage (W): 408
 Total Output Wattage (W): 347
 Max. Wattage Per Lamp (W): 0.6
 Dimming: 0-10V Dimming / Phase Dimming (120Vac Only)
 Driver Included: Yes
 Driver Location: Integrated
 Driver Type: Constant Voltage - Universal
 Driver Class: Class 1
 Input Voltage (V): 120 - 277
 Output Voltage (V): 12

LED

Number of LEDs: 680
 Color Temperature (°K): [2400](#) / [2800](#)
 Max. Delivered Lumen (lm): 20400
 CRI: >90 CRI
 Lamp Life (hrs): 50000

OPTICAL

RATINGS AND CERTIFICATIONS

Certified By: Certified for North American Standards
 IP rating: IP20

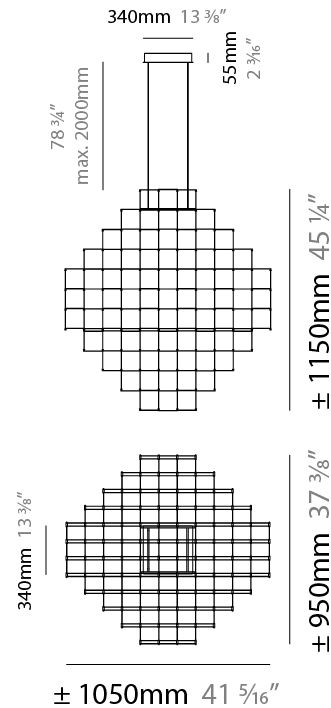
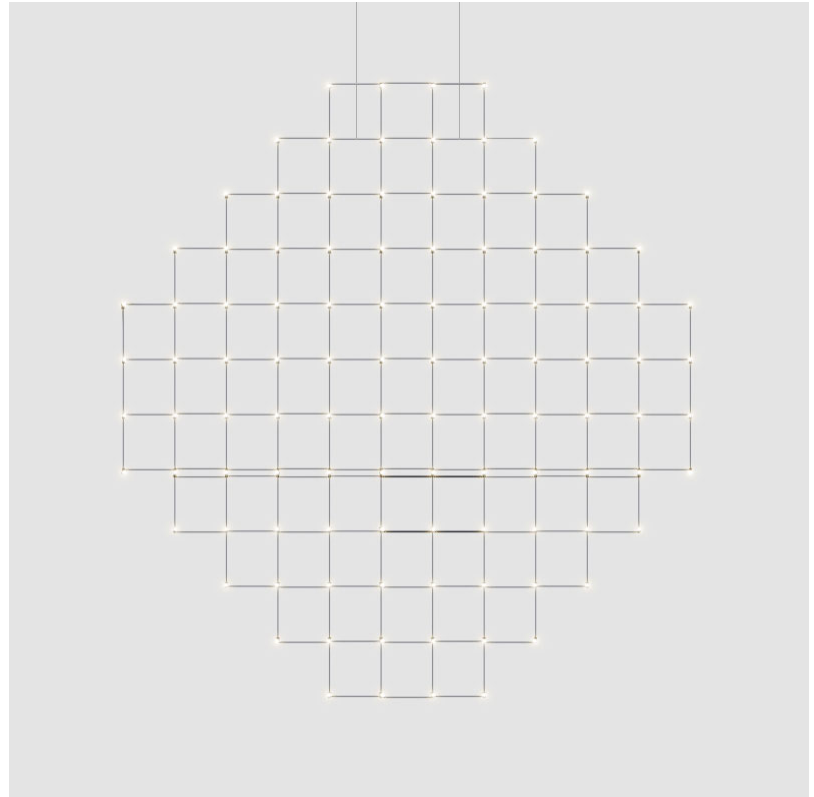

PIXEL SPHERE SUSPENSION

D1010078-

PROJECT

TYPE

SPECIFIER

QUANTITY

DATE

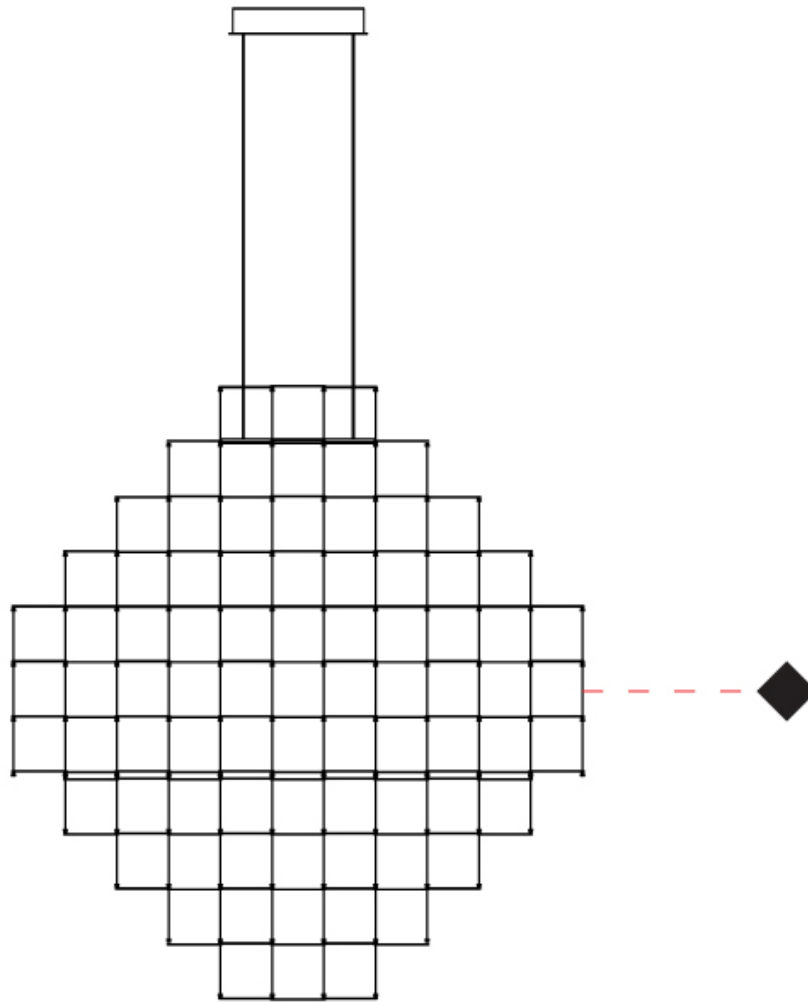

D

PIXEL SPHERE SUSPENSION

D1010079- -

base number Color Finish
 Temperature Options

PROJECT
TYPE
SPECIFIER
QUANTITY
DATE

- To build a product code in our configurator select the specify button on the base model # product page
- To build a manual product code on this datasheet choose from the options listed below in blue font and add the suffix to the base model #

GENERAL

Series: Pixel Sphere
 Partner: Quasar
 Division: Design
 Installation: Suspension
 Product Type: Chandelier
 Mounting Location: Ceiling

PHYSICAL

Shape: Sphere
 Diameter (mm): 1100
 Diameter (in): 43 ¹⁵/₁₆
 Width (mm): 125
 Width (in): 4 ¹⁵/₁₆
 Height (mm): 125
 Height (in): 4 ¹⁵/₁₆
 Max. Overall Height (mm): 2125
 Max. Overall Height (in): 83 ¹¹/₁₆
 Fixture Finish: [NIC](#) / [BRA](#) / [BBR](#)
 Fixture Material: Metal
 Cable Details: 2,000mm/78 3/4" Transparent Cable

ELECTRICAL

Lamp Type: LED
 Input Wattage (W): 288
 Total Output Wattage (W): 245
 Max. Wattage Per Lamp (W): 0.6
 Dimming: 0-10V Dimming / Phase Dimming (120Vac Only)
 Driver Included: Yes
 Driver Location: Integrated
 Driver Type: Constant Voltage - Universal
 Driver Class: Class 1
 Input Voltage (V): 120 - 277
 Output Voltage (V): 12

LED

Number of LEDs: 480
 Color Temperature (°K): [2400](#) / [2800](#)
 Max. Delivered Lumen (lm): 14400
 CRI: >90 CRI
 Lamp Life (hrs): 50000

OPTICAL

RATINGS AND CERTIFICATIONS

Certified By: Certified for North American Standards
 IP rating: IP20

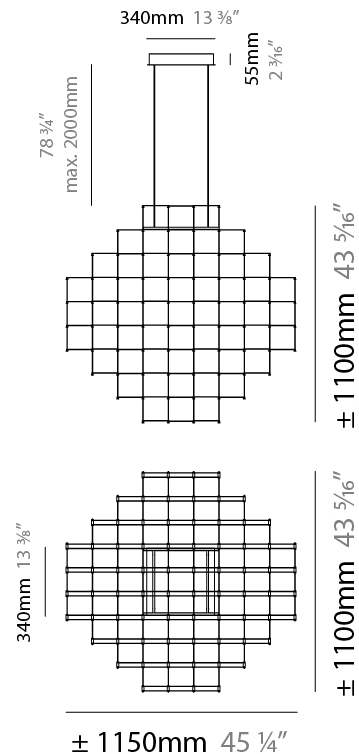
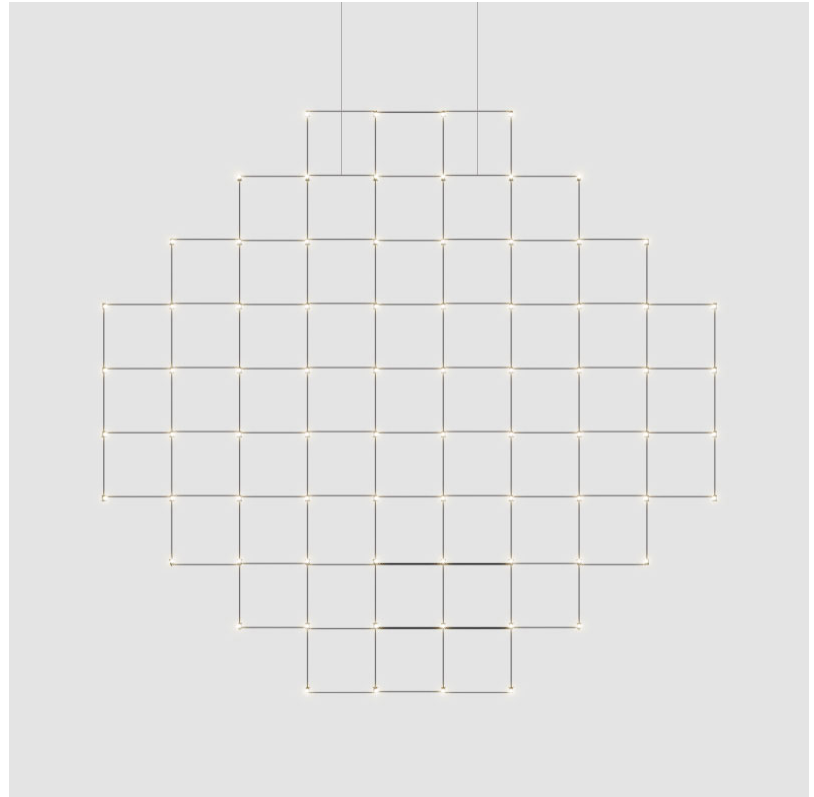

PIXEL SPHERE SUSPENSION

D1010079-

PROJECT _____

TYPE _____

SPECIFIER _____

QUANTITY _____

DATE _____

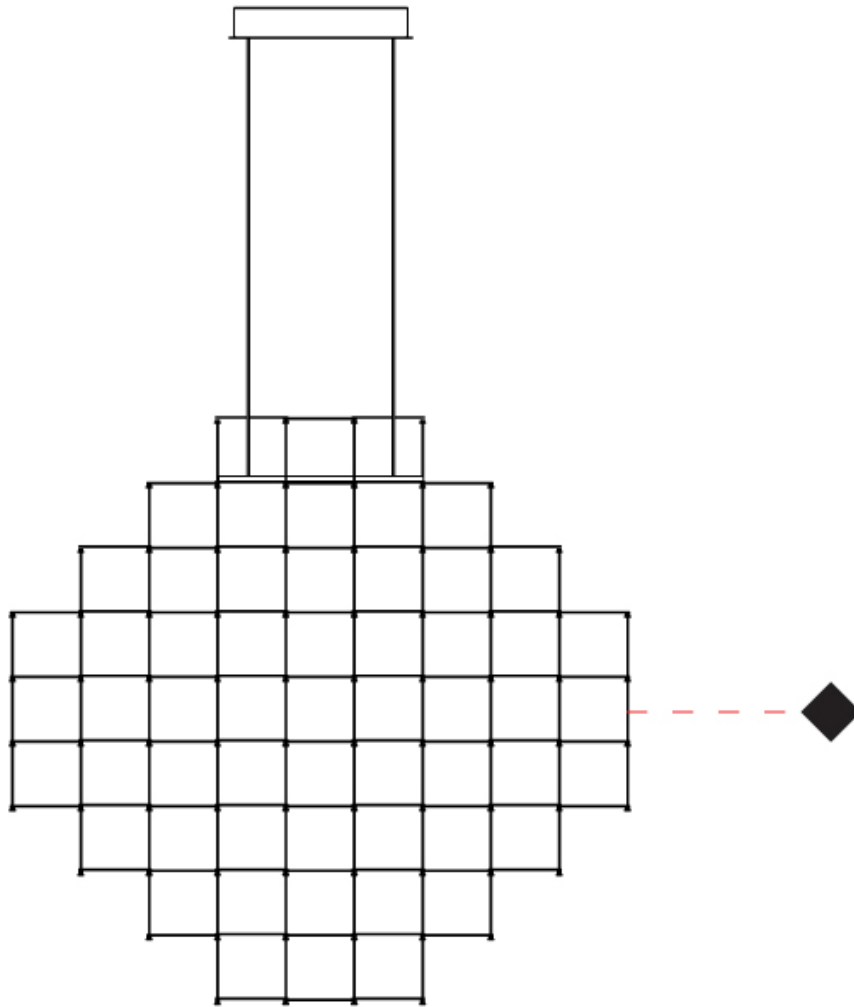

D

PIXEL SPHERE SUSPENSION

D1010080- -

base number Color Finish
 Temperature Options

- To build a product code in our configurator select the specify button on the base model # product page
- To build a manual product code on this datasheet choose from the options listed below in blue font and add the suffix to the base model #

GENERAL

Series: Pixel Sphere
 Partner: Quasar
 Division: Design
 Installation: Suspension
 Product Type: Chandelier
 Mounting Location: Ceiling

PHYSICAL

Shape: Sphere
 Diameter (mm): 1400
 Diameter (in): 55 1/8
 Width (mm): 100
 Width (in): 3 15/16
 Height (mm): 100
 Height (in): 3 15/16
 Max. Overall Height (mm): 2100
 Max. Overall Height (in): 82 11/16
 Fixture Finish: [NIC](#) / [BRA](#) / [BBR](#)
 Fixture Material: Metal
 Cable Details: 2,000mm/78 3/4" Transparent Cable

ELECTRICAL

Lamp Type: LED
 Input Wattage (W): 876
 Total Output Wattage (W): 745
 Max. Wattage Per Lamp (W): 0.6
 Dimming: 0-10V Dimming / Phase Dimming (120Vac Only)
 Driver Included: Yes
 Driver Location: Integrated
 Driver Type: Constant Voltage - Universal
 Driver Class: Class 1
 Input Voltage (V): 120 - 277
 Output Voltage (V): 12

LED

Number of LEDs: 1460
 Color Temperature (°K): [2400](#) / [2800](#)
 Max. Delivered Lumen (lm): 43800
 CRI: >90 CRI
 Lamp Life (hrs): 50000

OPTICAL

RATINGS AND CERTIFICATIONS

Certified By: Certified for North American Standards
 IP rating: IP20

PROJECT
TYPE
SPECIFIER
QUANTITY
DATE

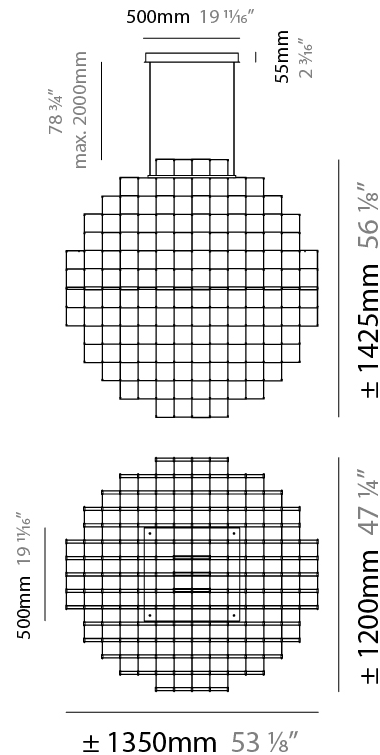
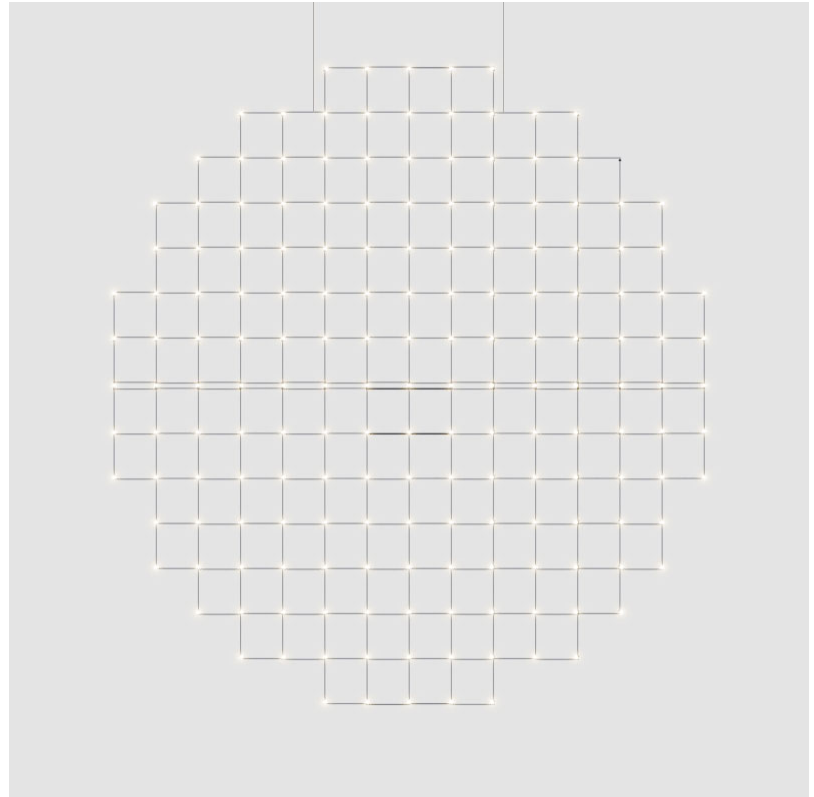

PIXEL SPHERE SUSPENSION

D1010080-

PROJECT

TYPE

SPECIFIER

QUANTITY

DATE

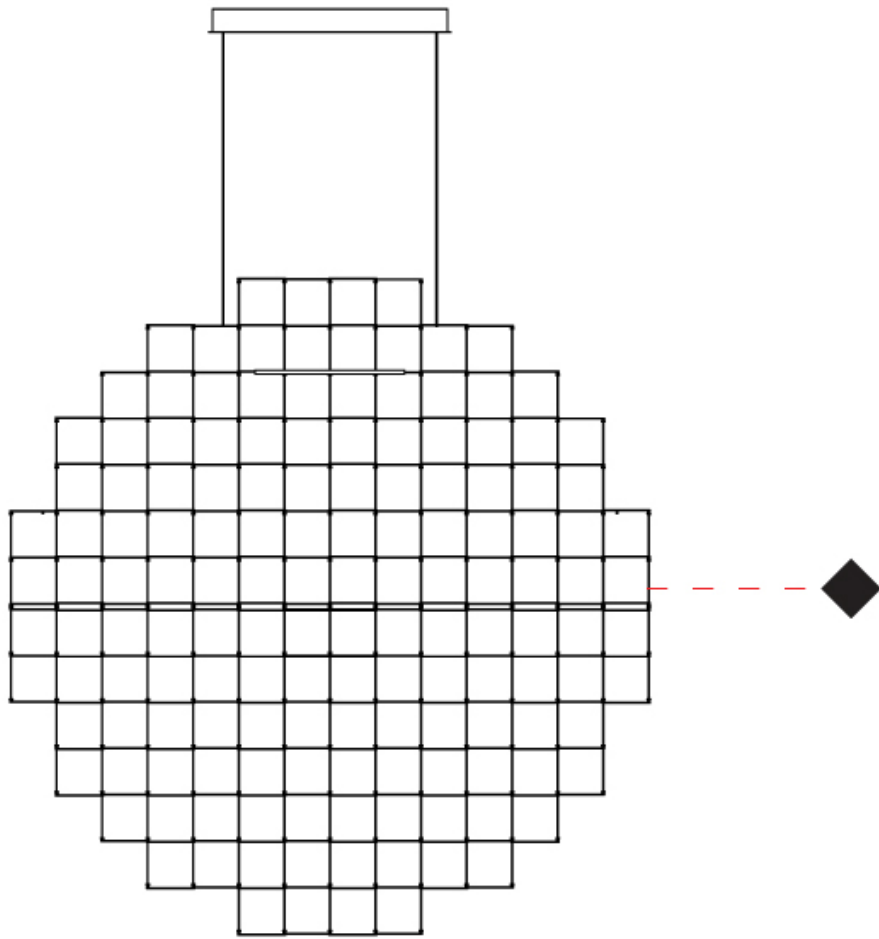

D

PIXEL SPHERE SUSPENSION

D1010081-

base number Color Finish
 Temperature Options

- To build a product code in our configurator select the specify button on the base model # product page
- To build a manual product code on this datasheet choose from the options listed below in blue font and add the suffix to the base model #

GENERAL

Series: Pixel Sphere
 Partner: Quasar
 Division: Design
 Installation: Suspension
 Product Type: Chandelier
 Mounting Location: Ceiling

PHYSICAL

Shape: Sphere
 Diameter (mm): 1400
 Diameter (in): 55 ¹/₈
 Width (mm): 125
 Width (in): 4 ¹⁵/₁₆
 Height (mm): 125
 Height (in): 4 ¹⁵/₁₆
 Max. Overall Height (mm): 2125
 Max. Overall Height (in): 83 ¹¹/₁₆
 Fixture Finish: [NIC](#) / [BRA](#) / [BBR](#)
 Fixture Material: Metal
 Cable Details: 2,000mm/78 3/4" Transparent Cable

ELECTRICAL

Lamp Type: LED
 Input Wattage (W): 408
 Total Output Wattage (W): 347
 Max. Wattage Per Lamp (W): 0.6
 Dimming: 0-10V Dimming / Phase Dimming (120Vac Only)
 Driver Included: Yes
 Driver Location: Integrated
 Driver Type: Constant Voltage - Universal
 Driver Class: Class 1
 Input Voltage (V): 120 - 277
 Output Voltage (V): 12

LED

Number of LEDs: 680
 Color Temperature (°K): [2400](#) / [2800](#)
 Max. Delivered Lumen (lm): 20400
 CRI: >90 CRI
 Lamp Life (hrs): 50000

OPTICAL

RATINGS AND CERTIFICATIONS

Certified By: Certified for North American Standards
 IP rating: IP20

PROJECT
TYPE
SPECIFIER
QUANTITY
DATE

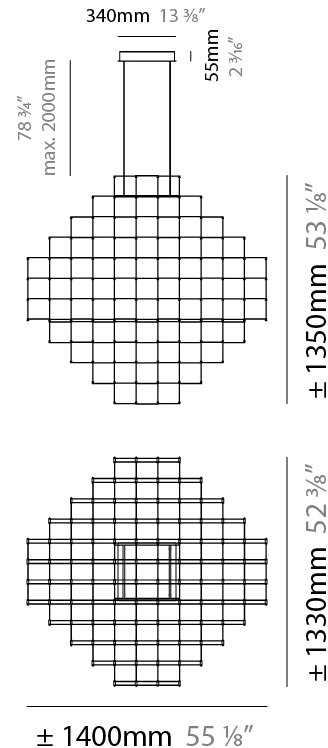
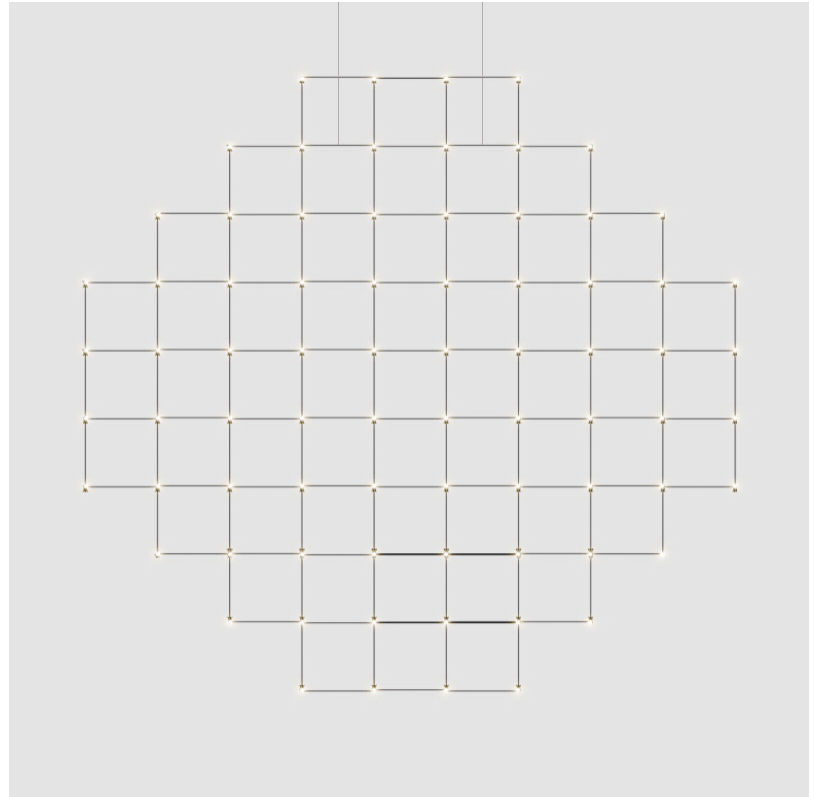

PIXEL SPHERE SUSPENSION

D1010081-

PROJECT

TYPE

SPECIFIER

QUANTITY

DATE

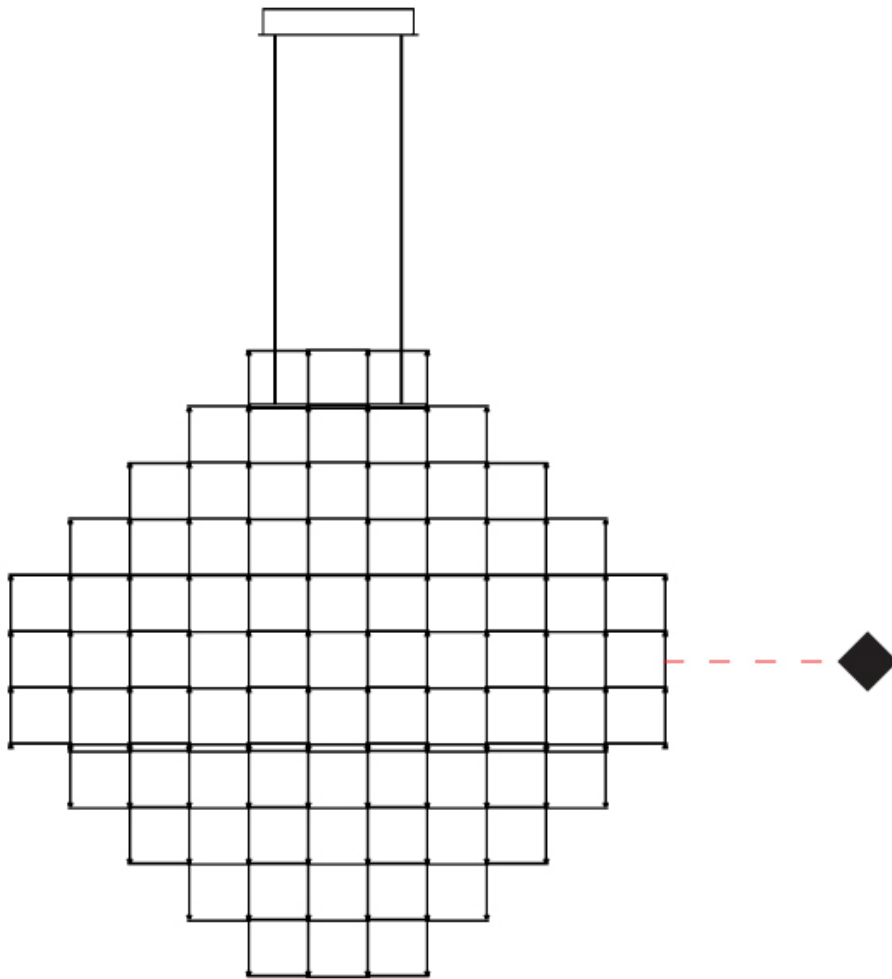

D

PROJECT	
TYPE	
SPECIFIER	
QUANTITY	
DATE	

PIXEL SPHERE SUSPENSION

D1010090-

base number	Color	Finish
	Temperature	Options

- To build a product code in our configurator select the specify button on the base model # product page
- To build a manual product code on this datasheet choose from the options listed below in blue font and add the suffix to the base model #

GENERAL

Series: Pixel Sphere
Partner: Quasar
Division: Design
Installation: Suspension
Product Type: Chandelier
Mounting Location: Ceiling

PHYSICAL

Shape: Sphere
Length (mm): 1350
Length (in): 53 1/8
Width (mm): 1200
Width (in): 47 1/4
Height (mm): 1430
Height (in): 56 5/16
Max. Overall Height (mm): 3430
Max. Overall Height (in): 135 1/16
Fixture Finish: NIC / BRA / BBR
Fixture Material: Metal
Cable Details: 2000mm/78 3/4" Transparent Cable

ELECTRICAL

Lamp Type: LED
Input Wattage (W): 876
Total Output Wattage (W): 745
Max. Wattage Per Lamp (W): 0.6
Dimming: 0-10V Dimming / Phase Dimming (120Vac Only)
Driver Included: Yes
Driver Location: Integrated
Driver Type: Constant Voltage - Universal
Driver Class: Class 1
Input Voltage (V): 120 - 277
Output Voltage (V): 12

LED

Number of LEDs: 1476
Color Temperature (°K): 2400 / 2800
Max. Delivered Lumen (lm): 33580
CRI: >90 CRI
Lamp Life (hrs): 50000

OPTICAL

RATINGS AND CERTIFICATIONS

Certified By: Certified for North American Standards
IP rating: IP20

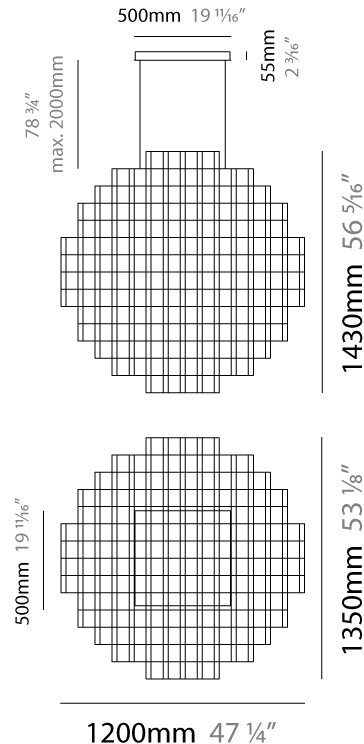
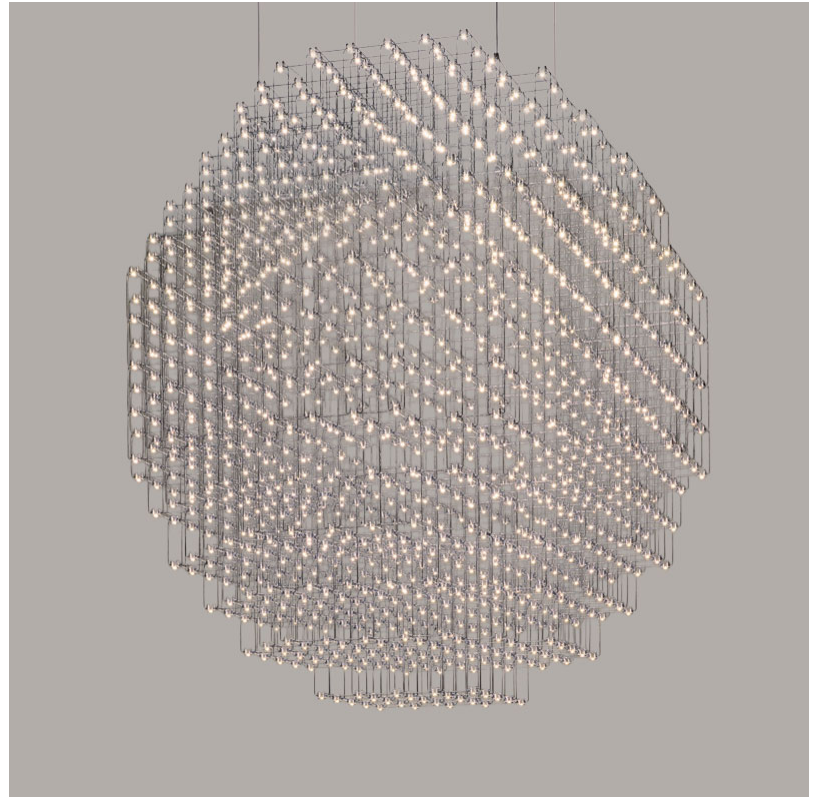

PIXEL SPHERE SUSPENSION

D1010090-

PROJECT

TYPE

SPECIFIER

QUANTITY

DATE

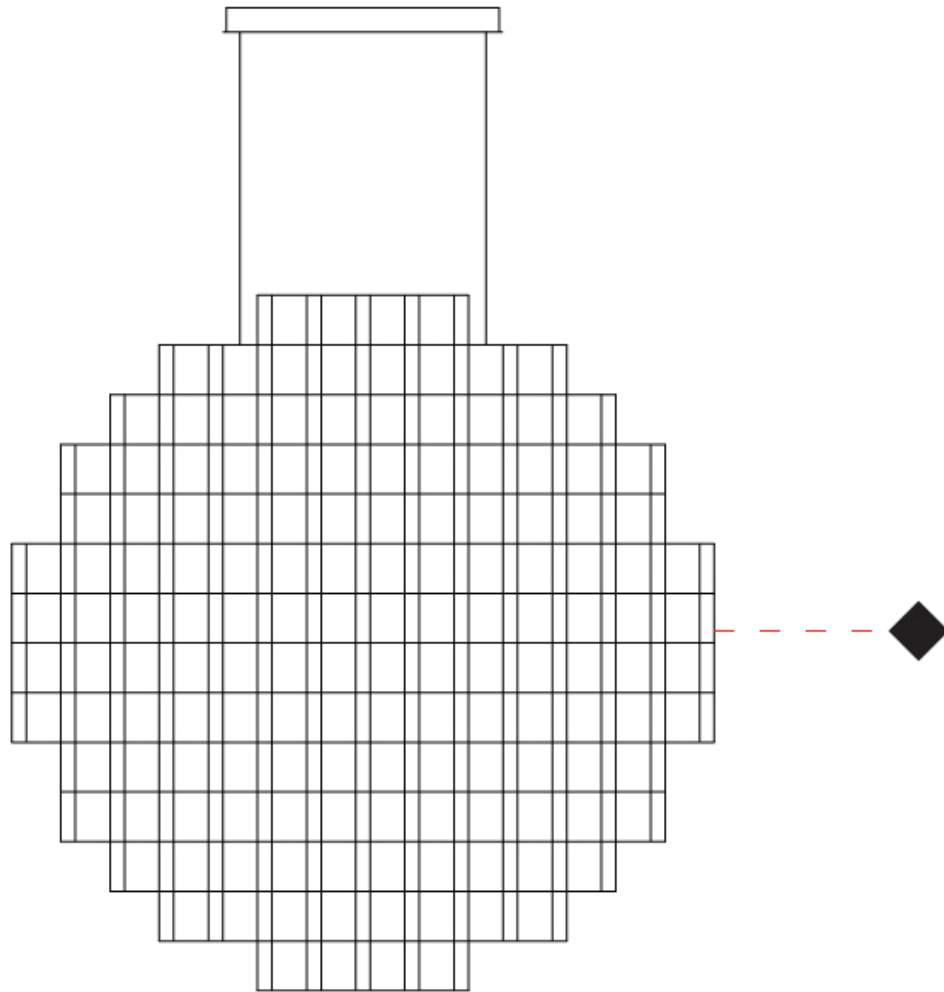

D

PROJECT	
TYPE	
SPECIFIER	
QUANTITY	
DATE	

PIXEL SPHERE SUSPENSION

D1010090- : D1010090-28K-BBR

base number Color Finish
Temperature Options

- To build a product code in our configurator select the specify button on the base model # product page
- To build a manual product code on this datasheet choose from the options listed below in blue font and add the suffix to the base model #

GENERAL

Series: Pixel Sphere
 Partner: Quasar
 Division: Design
 Installation: Suspension
 Product Type: Chandelier
 Mounting Location: Ceiling

PHYSICAL

Shape: Sphere
 Length (mm): 1350
 Length (in): 53 1/8
 Width (mm): 1200
 Width (in): 47 1/4
 Height (mm): 1430
 Height (in): 56 5/16
 Max. Overall Height (mm): 3430
 Max. Overall Height (in): 135 1/16
 Fixture Finish: [NIC](#) / [BRA](#) / [BBR](#)
 Fixture Material: Metal
 Cable Details: 2000mm/78 3/4" Transparent Cable

ELECTRICAL

Lamp Type: LED
 Input Wattage (W): 876
 Total Output Wattage (W): 745
 Max. Wattage Per Lamp (W): 0.6
 Dimming: 0-10V Dimming / Phase Dimming (120Vac Only)
 Driver Included: Yes
 Driver Location: Integrated
 Driver Type: Constant Voltage - Universal
 Driver Class: Class 1
 Input Voltage (V): 120 - 277
 Output Voltage (V): 12

LED

Number of LEDs: 1476
 Color Temperature (°K): [2400](#) / [2800](#)
 Max. Delivered Lumen (lm): 33580
 CRI: >90 CRI
 Lamp Life (hrs): 50000

OPTICAL

RATINGS AND CERTIFICATIONS

Certified By: Certified for North American Standards
 IP rating: IP20

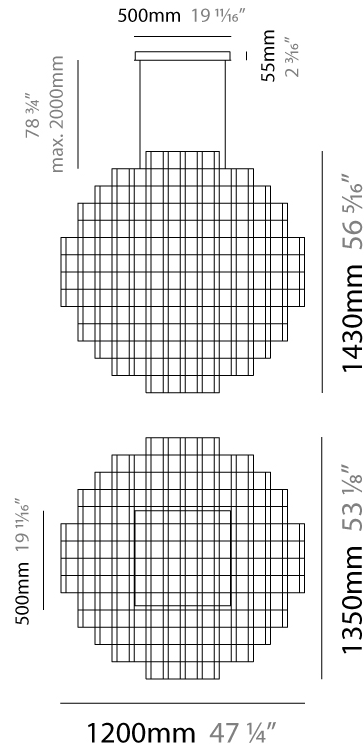
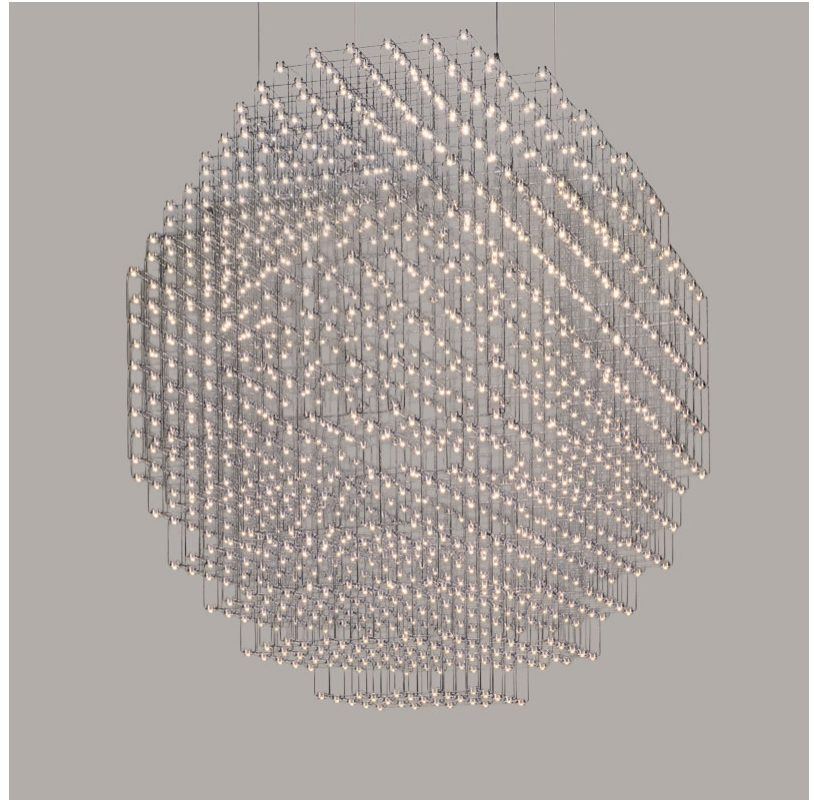

PIXEL SPHERE SUSPENSION

D1010090- : D1010090-28K-BBR

PROJECT

TYPE

SPECIFIER

QUANTITY

DATE

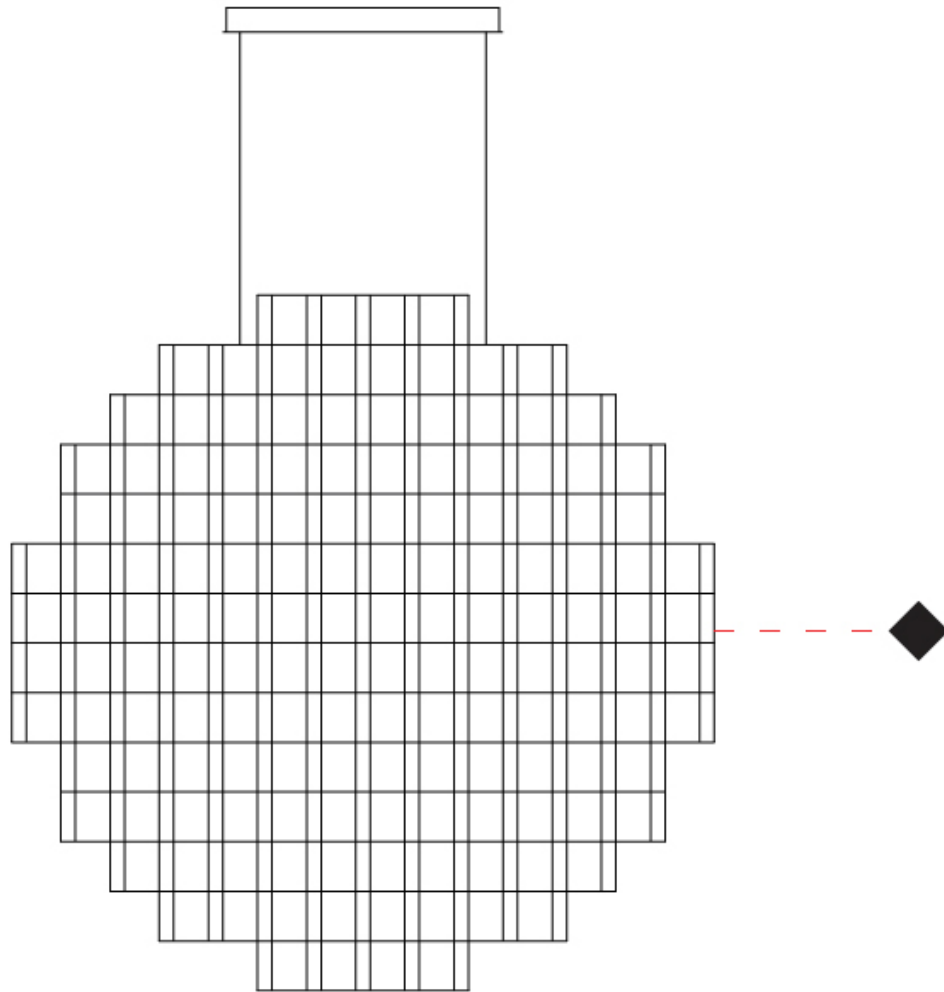

D

PIXEL SPHERE COLOR FINISH CHART

PROJECT	_____
TYPE	_____
SPECIFIER	_____
QUANTITY	_____
DATE	_____

Fixture Finish

Nickel - NIC



Brass - BRA



Black Brass - BBR

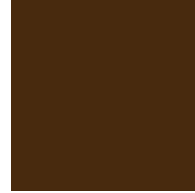

Digital: Not all screens are calibrated the same, and therefore, colors will appear differently between screens.

Physical: When texture is involved, there will be variations in color, character and tone within a product series and between product families.

Brass, nickel and copper are natural minerals and can potentially change color and show marks over time. We cannot guarantee the color appearance as the material transforms.



LEGEND

	floor-mounted		pivotal		special LED (upon request) RGB, RGBW, tunable, gold+, meat+, art+, fashion+
	wall and ceiling: recessed and surface mounted		rotating		warm dim / natural dimming LED
	ceiling-mounted and wall-mounted		illuminate tilted		rechargeable battery powered
	wall-mounted		color of suspension cable		fixture with natural vivid LED (upon request)
	omni-directional light distribution		length of suspension cable		color rendering index
	direct light distribution		reflector degree selection		color temperature
	direct/indirect light distribution		super spot		lumen (luminous flux)
	indirect light distribution		lens		efficacy (lumens per watt)
	asymmetric light distribution		lens pack		Unified Glare Rating (UGR) range from 5-40
	aura light distribution		shine ring		marine grade (AISI 316 stainless steel)
	round wall or ceiling cut-out		integrated shine ring with diffuser		walk on
	square wall or ceiling cut-out		free individual colors 01-29		drive on
	the supplied jig specifies the cutout dimensions		individual colors: 00 (free of charge), 01-25 (extra charge)		Dark Sky Compliance
	minimum distance (meters) lamp - object		luminaire part to be colored (F1)		Americans with Disabilities Act (less than 4" off the wall located between 27"-84" from floor)
	recessed depth		luminaire part to be colored (F2)		lamp protected against explosion
	ceiling thickness in mm		luminaire part to be colored (F3)		blown glass using traditional methods by master glass blower
	ceiling thickness selection		luminaire part to be colored (F4)		acoustic material
	dimnable DP (phase), DV (0-10V), DD (dali), DS (step-dim)		luminaire part to be colored (F5)		protection class I, protection insulation
	included or excluded LED driver/transformer/control gear		color of 3-circuit adaptor		protection class II, protection insulation
	separately switchable		indirect diffuser		ETL Certified to UL and CSA Standards
	sensor		direct diffuser		UL Certified to UL and CSA Standards
	remote control		ball-proof (upon request)		CSA Certified to UL and CSA Standards
	available upon request		accessory		Certified for North American Standards

IP RATING

	protected against ingress of solid bodies greater than 12.5mm (finger)
	protected against ingress of solid bodies greater than 2.5mm protected against sprays of water up to 60 degrees from the vertical (rain)
	protected against ingress of solid bodies greater than 1mm (wire) no protection against the ingress of moisture
	protected against ingress of solid bodies greater than 1mm (wire) protected against sprays of water up to 60 degrees from the vertical (rain)
	protected against ingress of solid bodies greater than 1mm (wire) protected against water splashed from all directions
	protected against limited ingress of dust (wet rooms/covered outdoor areas) protected against water splashed from all directions
	protected against ingress of dust protected against jets of water
	protected against ingress of dust protected against powerful jets of water or heavy seas
	protected against ingress of dust protected against immersion of water between 15cm - 1m for 30 minutes
	protected against ingress of dust protected against immersion of water under pressure for long periods

IK RATING

	protected against 0.14 joules impact (equivalent to 0.25kg mass dropped from 56mm above the surface)
	protected against 0.2 joules impact (equivalent to 0.25kg mass dropped from 80mm above the surface)
	protected against 0.35 joules impact (equivalent to 0.25kg mass dropped from 140mm above the surface)
	protected against 0.5 joules impact (equivalent to 0.25kg mass dropped from 200mm above the surface)
	protected against 0.7 joules impact (equivalent to 0.25kg mass dropped from 280mm above the surface)
	protected against 1 joules impact (equivalent to 0.25kg mass dropped from 400mm above the surface)
	protected against 2 joules impact (equivalent to 0.5kg mass dropped from 400mm above the surface)
	protected against 5 joules impact (equivalent to 1.7kg mass dropped from 300mm above the surface)
	protected against 10 joules impact (equivalent to 5.0kg mass dropped from 200mm above the surface)
	protected against 20 joules impact (equivalent to 5.0kg mass dropped from 400mm above the surface)